



11/16-

VOLKSWAGEN CRAFTER II platform (pick-up)  
L3= 3640mm, L4=4490mm, single tyres, FWD

Cat. No. **W/050**

**E20**

E20 55R-01

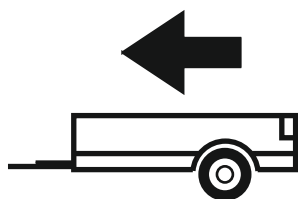

3000kg

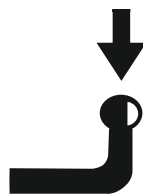

140kg

**D** = 15,85kN

D (kN) =



MAX kg

x

MAX kg

x 0,00981



MAX kg

+

MAX kg



IMIOLA HAK-POL

96-111 KOWIESY, CHOJNATA 23A, POLAND

Tel. + 48 46 831 73 31, fax +48 831 74 29

e-mail: [office@imiola.pl](mailto:office@imiola.pl), [www.imiola.pl](http://www.imiola.pl)

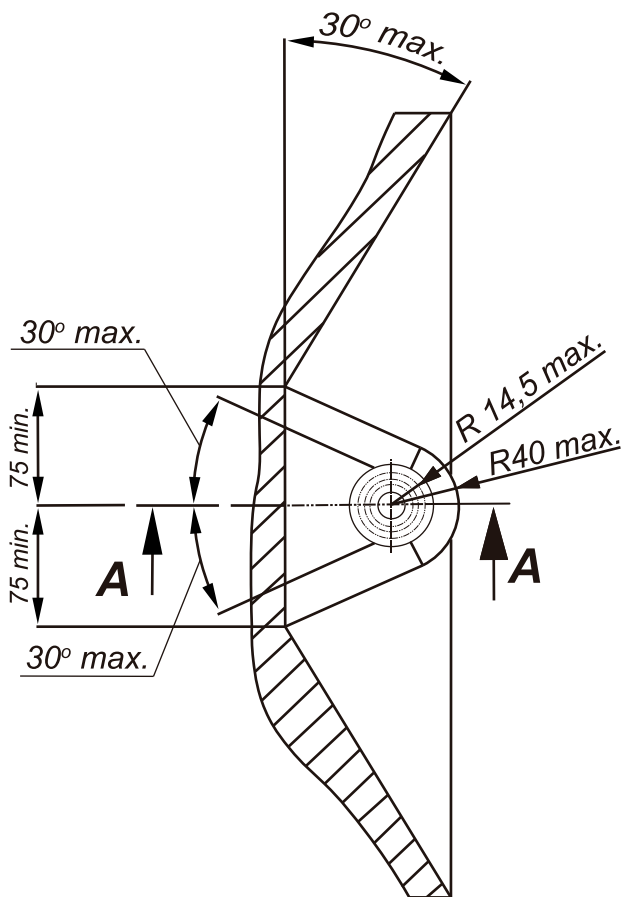

## PRZEKRÓJ A-A

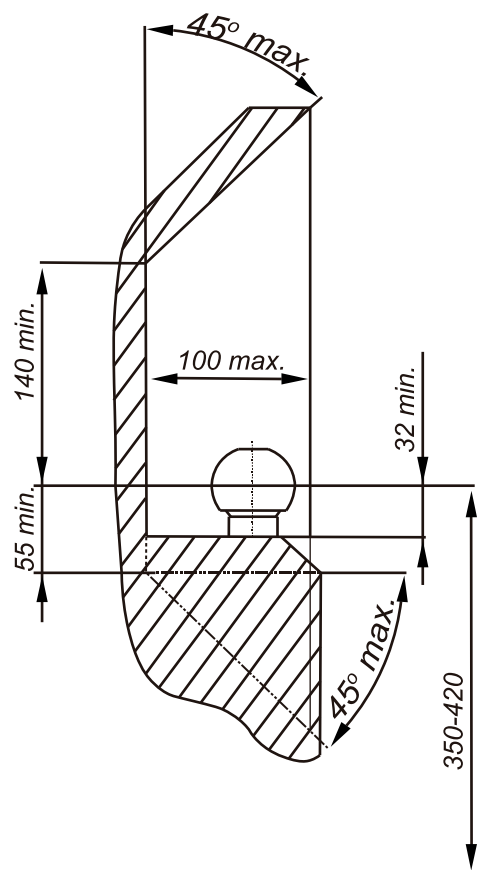

**PL** Należy zagwarantować przestrzeń swobodną według załącznika VII, rysunek 25a/b Regulaminu EKG ONZ 55.01 przy dopuszczalnym ciężarze całkowitym pojazdu.

**F** L'espace libre doit être garanti conformément à l'annexe VII, illustration de la réglementation 55.01 CE pour un poids total en charge autorisé du véhicule.





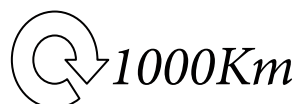

**GB** The clearance specified in appendix VII, diagram 25a/b of Regulation No. 55.01 UN EU must be guaranteed at laden weight of the vehicle.

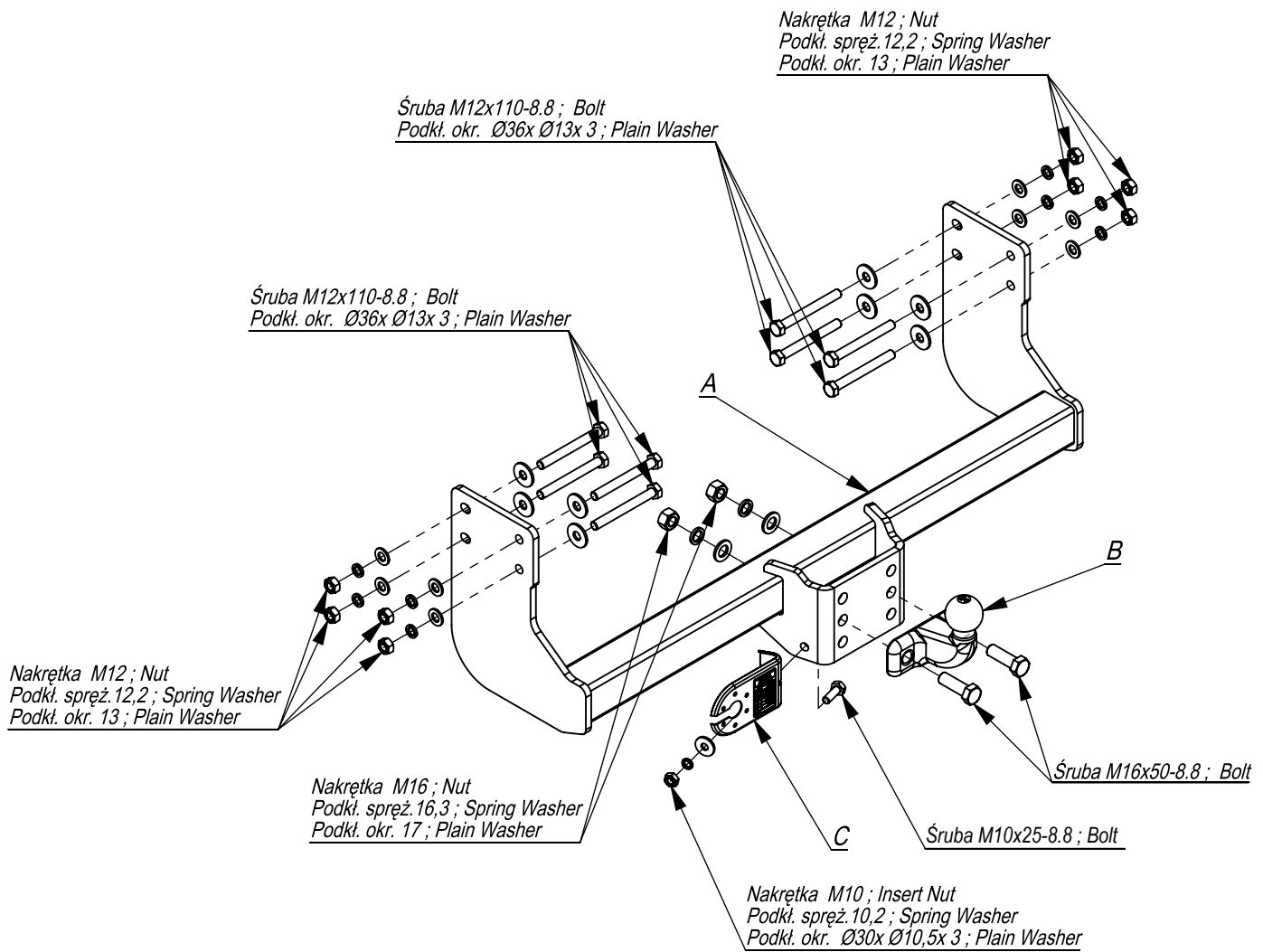
**D** Der Freiraum nach Anhang VII, Abbildung 25a/b der Vorschriften 55.01 EG ist zu gewährleisten bei zulässigem Gesamtgewicht des Fahrzeuges.

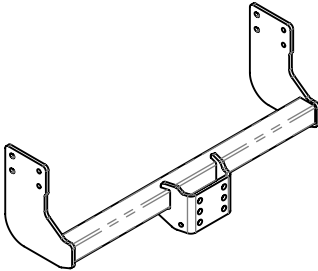
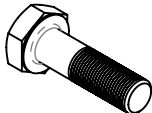
Moment skręcający dla śrub i nakrętek (8.8) Torque settings for nuts and bolts (8.8)	
M8	25Nm
M10	55Nm
M12	85Nm
M14	135Nm
M16	195Nm





	A	x1		M16x50	2
				M12x110	8
				M10x25	1
	B	x1		M16	2
				M12	8
				M10	1
	C	x1		Ø30xØ10,5x3	1
				Ø36xØ13x3	6
					17
13	8				
	16,3	2			
	12,2	8			
	10,2	1			

Nakrętka M12 ; Nut  
 Podkł. spręż. 12,2 ; Spring Washer  
 Podkł. okr. 13 ; Plain Washer

Pkt. 1

Śruba M12x110-8.8 ; Bolt  
 Podkł. okr. Ø36xØ13x3 ; Plain Washer

Pkt. 1

Nakrętka M12 ; Nut  
 Podkł. spręż. 12,2 ; Spring Washer  
 Podkł. okr. 13 ; Plain Washer

Nakrętka M16 ; Nut  
 Podkł. spręż. 16,3 ; Spring Washer  
 Podkł. okr. 17 ; Plain Washer

Nakrętka M10 ; Insert Nut  
 Podkł. spręż. 10,2 ; Spring Washer  
 Podkł. okr. Ø30xØ10,5x3 ; Plain Washer

Śruba M16x50-8.8 ; Bolt

Śruba M10x25-8.8 ; Bolt

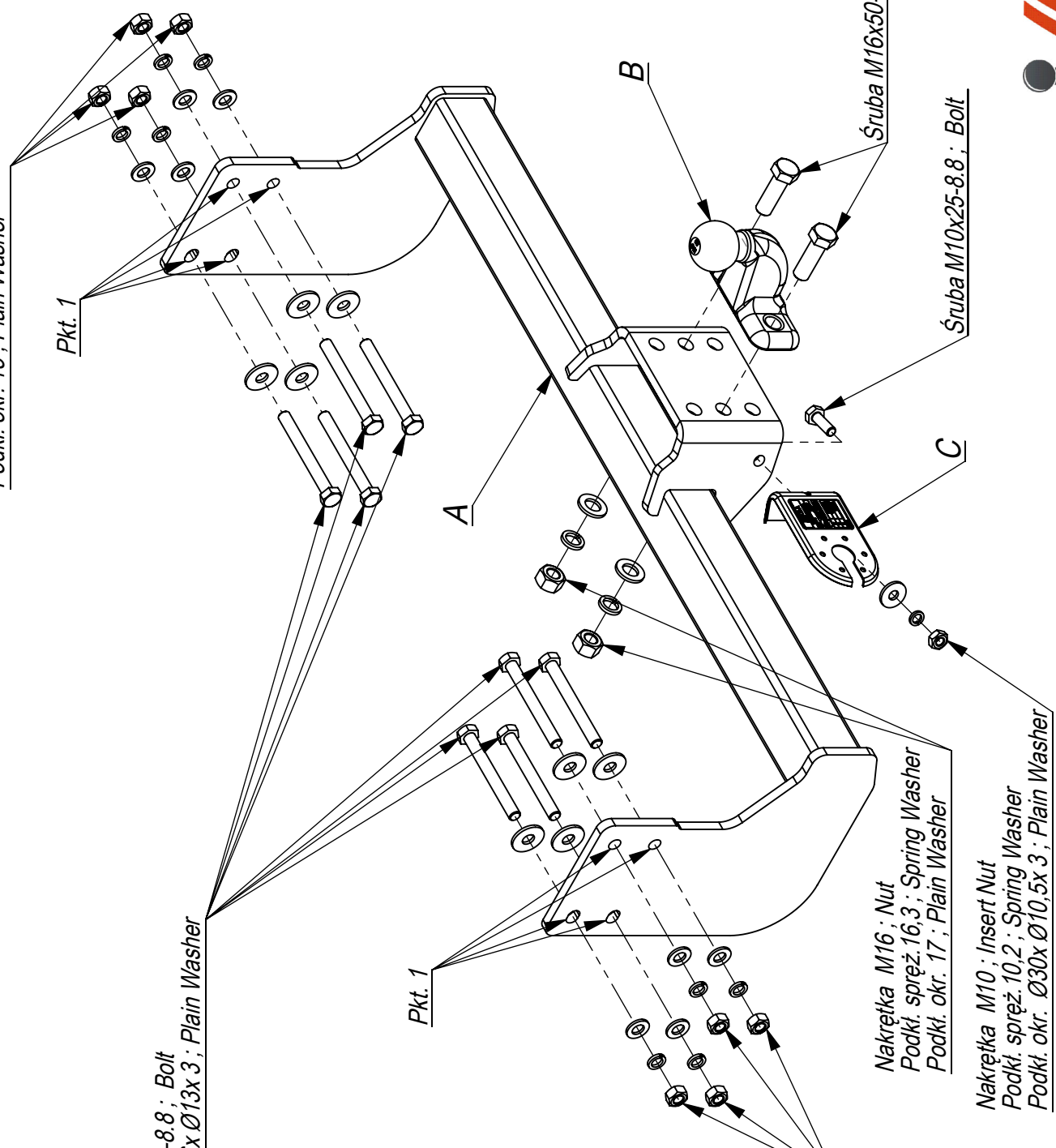

Nr katalogowy Marka

W/050

VW Crafter II (skrz.,poj.koła,nap.przedni)

od 11/2016 ->

96-111 Kowiesy, Chojnata 23 A  
 tel. +48 46 831 73 31

- Poprzez otwory w ramie przykręcić lekko belkę zaczepu A śrubami M12x110 8.8 (pkt 1).
- Dokręcić wszystkie śruby z momentem wg tabeli.
- Przykręcić kulę i blachę gniazda elektrycznego śrubami M16x50 8.8.
- Podłączyć instalację elektryczną.

- Screw slightly the main bar A, through the holes in the chassis, with bolts M12x110 8.8 (point 1).
- Tighten all the bolts according to the torque setting- see the table.
- Fix the ball and electric plate with bolts M16x50 8.8.
- Connect the electric wires.

- Visser legçremet la traverse d'attache A, a travers les ouvertures de renfort, par les boulons M12x110 8.8 (point 1),
- Serrer tous les boulons avec un couple de serrage selon tableau
- Visser le crochet d'attelage et socle de prise électrique par les boulons M16x50 8.8.
- Raccorder le circuit électrique.

- Durch die Öffnung im Gestell, den Querbalken A mit den Schrauben M12x110 (Punkt 1) locker anschrauben.
- Alle Schrauben mit dem in der Tabelle angegebenen Drehmoment festziehen.
- Die Kugel mit der Steckdosenhalterung mit den Schrauben M16x50 8.8 anschrauben.
- Die Elektroinstallation anschließen.

- Poner la viga de la bola y atornillarla con tornillos M12x110 8.8 (p. 1).
- Apretar todos los tornillos con el par según la tabla anterior.
- Apretar la bola y la placa eléctrica con tornillos M16x50 8.8.
- Conectar la instalación eléctrica.

