



## VOLVO XC 90

2015 -

Cat. No. V/034

**E20**

E20\*55R01/07\*005500\*00

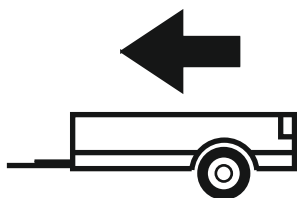

2700kg

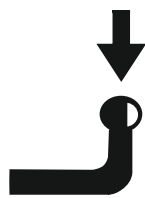

140kg

**D** = 13,40kN

**D (kN) =**



MAX kg

x

MAX kg

x 0,00981



MAX kg

+

MAX kg



IMIOLA HAK-POL

96-111 KOWIESY, CHOJNATA 23A, POLAND

Tel. + 48 46 831 73 31, fax +48 831 74 29

e-mail: office@imiola.pl, www.imiola.pl



## PRZEKRÓJ A-A



**PL** Należy zagwarantować przestrzeń swobodną według załącznika VII, rysunek 25a/b Regulaminu EKG ONZ 55.01 przy dopuszczalnym ciężarze całkowitym pojazdu.

**F** L'espace libre doit être garanti conformément à l'annexe VII, illustration de la réglementation 55.01 CE pour un poids total en charge autorisé du véhicule.







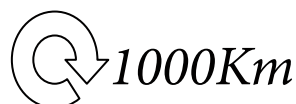

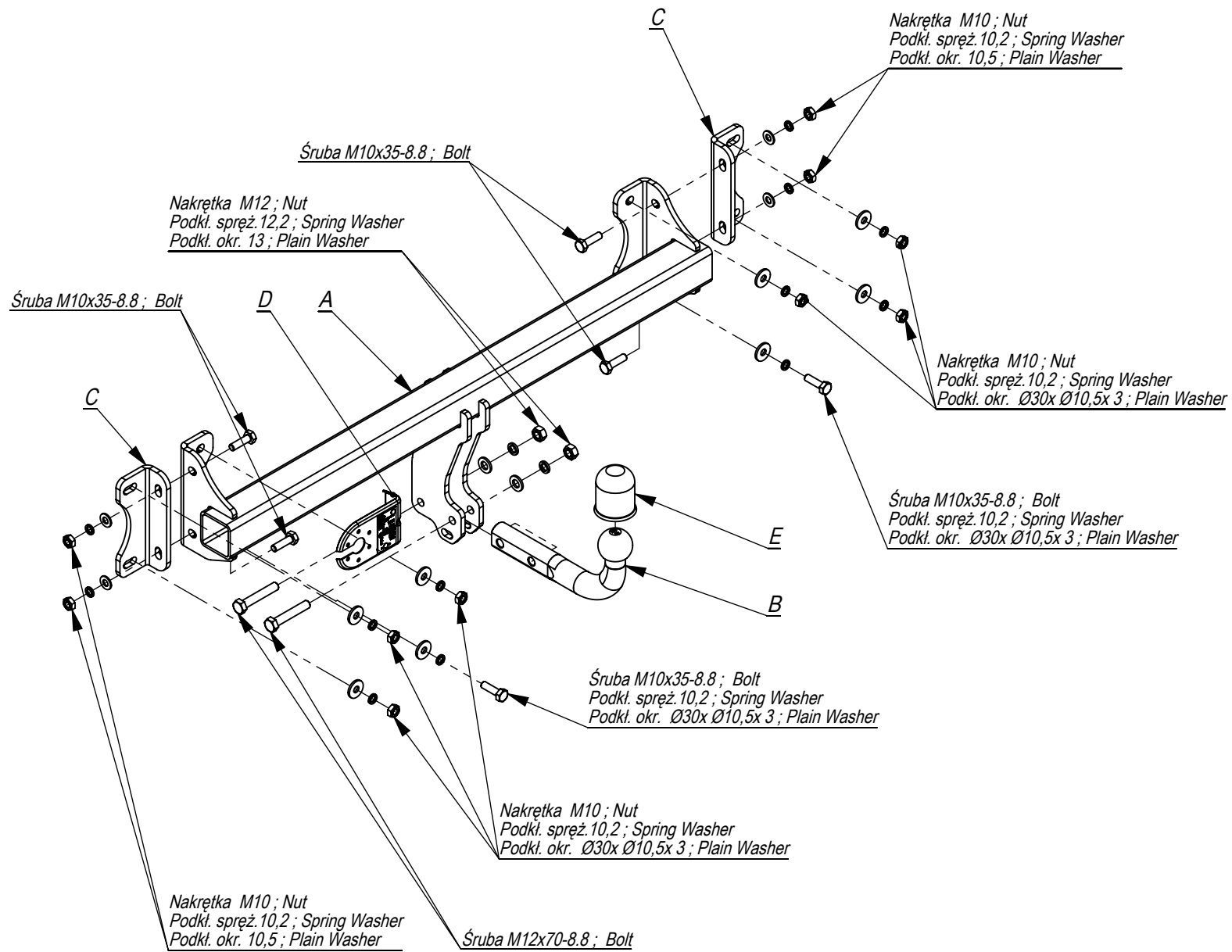
**GB** The clearance specified in appendix VII, diagram 25a/b of Regulation No. 55.01 UN EU must be guaranteed at laden weight of the vehicle.

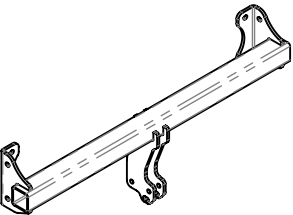
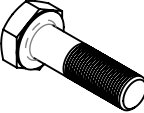
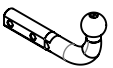
**D** Der Freiraum nach Anhang VII, Abbildung 25a/b der Vorschriften 55.01 EG ist zu gewährleisten bei zulässigem Gesamtgewicht des Fahrzeuges.

Moment skręcający dla śrub i nakrętek (8.8) Torque settings for nuts and bolts (8.8)	
M8	25Nm
M10	55Nm
M12	85Nm
M14	135Nm
M16	195Nm





	A	x1		M12x70	2
				M10x35	6
	B	x1		M12	2
				M10	10
	C	x2		Ø30xØ10,5x3	8
				13	2
	D	x1		10,5	4
				12,2	2
	E	x1		10,2	12

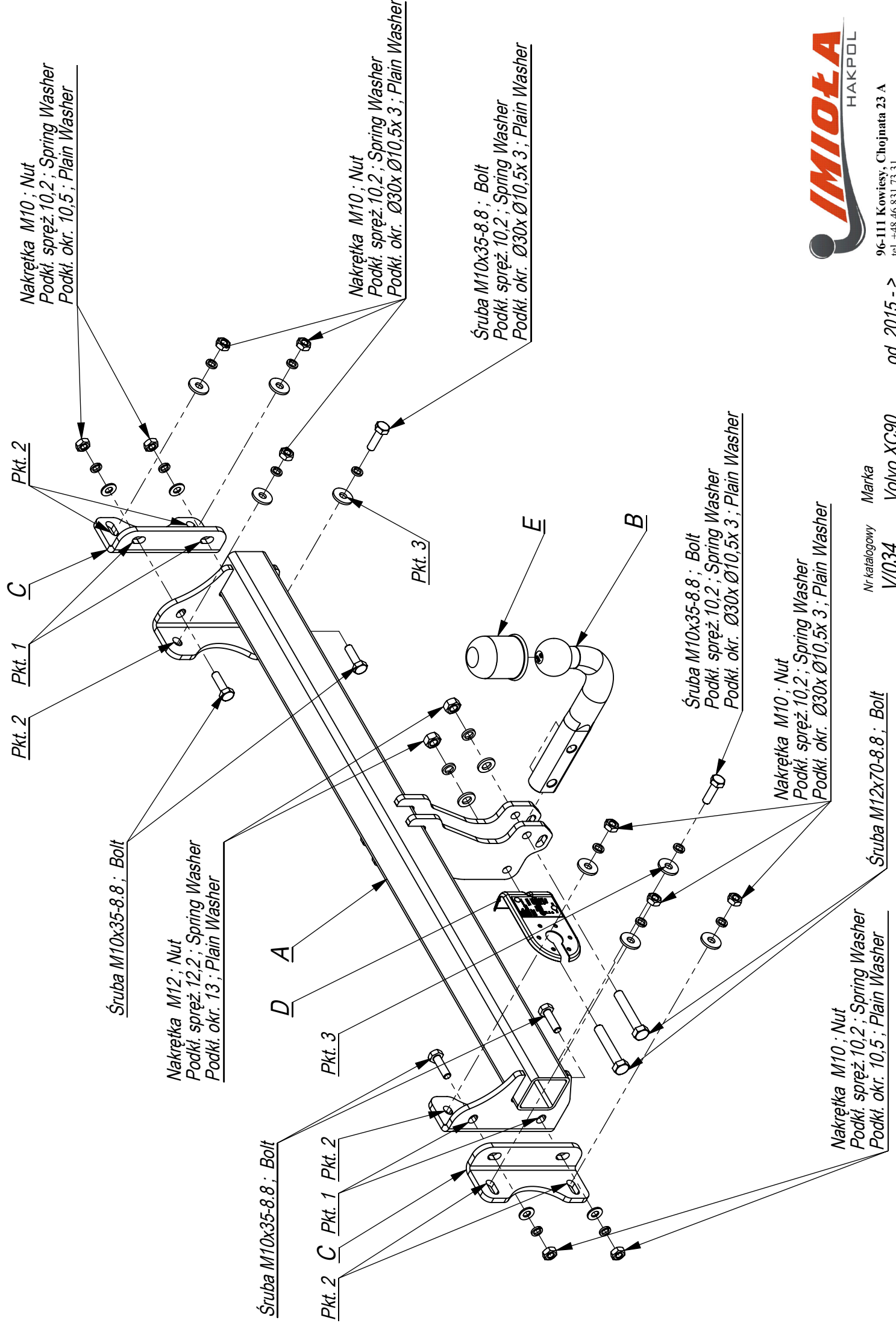

- Odkręcić zderzak i lampy.
- Odkręcić belkę zderzeniową (nie będzie już wykorzystana).
- Przykręcić belkę haka A do tylnego pasa nakrętkami M10 (pkt2) oraz śrubą M10 x35 (pkt3)  
Przykręcić elementy C do tylnego pasa nakrętkami M10 (pkt2) oraz do belki haka A śrubami M10x35 (pkt1) .
- Dokręcić wszystkie śruby z momentem według tabeli.
- Wykonać wycięcie w środkowej części zderzaka na uchwyt kuli.
- Przykręcić zderzak i lampy.
- Dokręcić kulę i blachę gniazda elektrycznego.
- Podłączyć instalację elektryczną.

- Unscrew the bumper and lamps.
- Unscrew the bumper bar (it will not be used any more).
- Screw the main bar A to the rear belt with nuts M10 (point 2) and with bolt M10x35 8.8 (point 3).  
Screw the elements C to the rear belt with nuts M10 (point 2) and to the main bar A with bolts M10x35 8.8 (point 1).
- Tighten all the bolts according to the torque setting –see the table.
- Cut out the fragment in the lower part of bumper to fit the handles of towball.
- Assemble the bumper and lamps.
- Fix the ball and electric plate.
- Connect the electric wires.

- Dévissez le pare-chocs et les lampes.
- Dévissez le pare-chocs (il ne sera plus utilisé).
- Visser la barre principale A sur la ceinture arrière avec les écrous M10 (point 2) et avec le boulon M10x35 8.8 (point 3). Visser les éléments C à la ceinture arrière avec les écrous M10 (point 2) et à la barre principale A avec boulons M10x35 8.8 (point 1).
- Serrez tous les boulons en fonction du couple de serrage -voir le tableau.
- Découpez le fragment dans la partie inférieure du pare-chocs pour l'adapter aux poignées de la boule d'attelage.
- Assembler le pare-chocs et les lampes.
- Fixez la boule et la plaque électrique.
- Connectez les fils électriques.

- Schrauben Sie die Stoßstange und die Lampen ab.
- Schrauben Sie die Stoßstange ab (sie wird nicht mehr verwendet).
- Schrauben Sie die Hauptstange A mit den Muttern M10 (Punkt 2) und mit der Schraube M10x35 8.8 (Punkt 3) an den hinteren Riemen. Schrauben Sie die Elemente C mit den Muttern M10 (Punkt 2) und mit der Hauptstange A an den hinteren Riemen Schrauben M10x35 8.8 (Punkt 1).
- Ziehen Sie alle Schrauben entsprechend der Drehmomenteinstellung fest - siehe Tabelle.
- Schneiden Sie das Fragment im unteren Teil des Stoßfängers aus, um es an die Größe der Kugelstange anzupassen.
- Montieren Sie die Stoßstange und die Lampen.
- Befestigen Sie den Ball und die elektrische Platte.
- Schließen Sie die elektrischen Kabel an.

- Desenrosque el parachoques y las lámparas.
- Desenrosque la barra del parachoques (no se usará más).
- Atornille la barra principal A a la correa trasera con tuercas M10 (punto 2) y con perno M10x35 8.8 (punto 3).  
Atornille los elementos C a la correa trasera con tuercas M10 (punto 2) y a la barra principal A con pernos M10x35 8.8 (punto 1).
- Apriete todos los pernos de acuerdo con la configuración de torque: vea la tabla.
- Recorta el fragmento en la parte inferior del parachoques para que quepa en las manijas de la bola de remolque.
- Montar el parachoques y las lámparas.
- Repare la bola y la placa eléctrica.
- Conecte los cables eléctricos.

