



2005-

TOYOTA RAV-4

Cat. No. **T/027**

e20

e20*94/20*0604*00

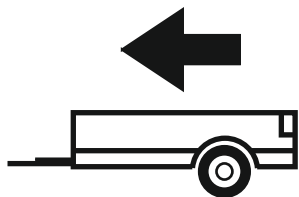

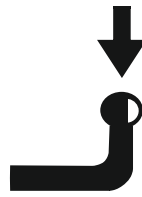

2050kg



90kg

D=10,41kN

$$D \text{ (kN)} = \frac{\text{MAX kg} \times \text{MAX kg}}{\text{MAX kg} + \text{MAX kg}} \times 0,00981$$

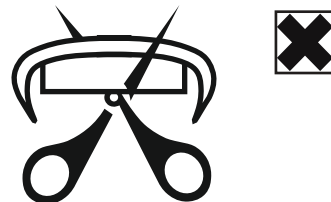
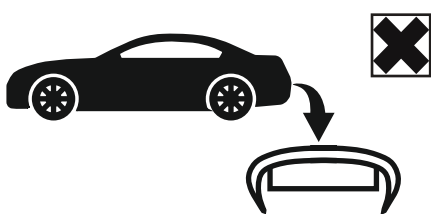



IMIOLA HAK-POL

96-111 KOWIESY, CHOJNATA 23A, POLAND

Tel. + 48 46 831 73 31, fax +48 831 74 29

e-mail: office@imiola.pl, www.imiola.pl

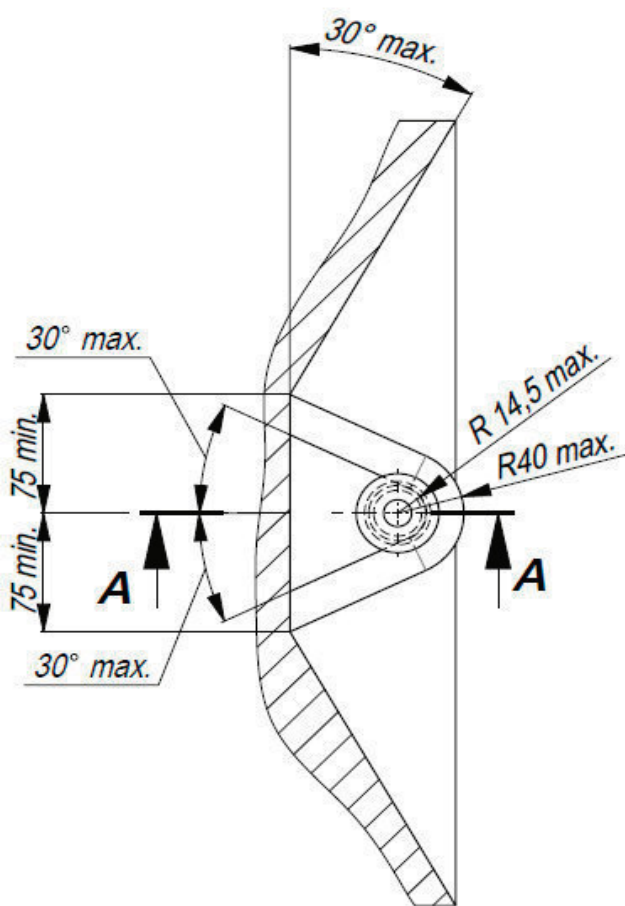

PRZEKRÓJ A-A

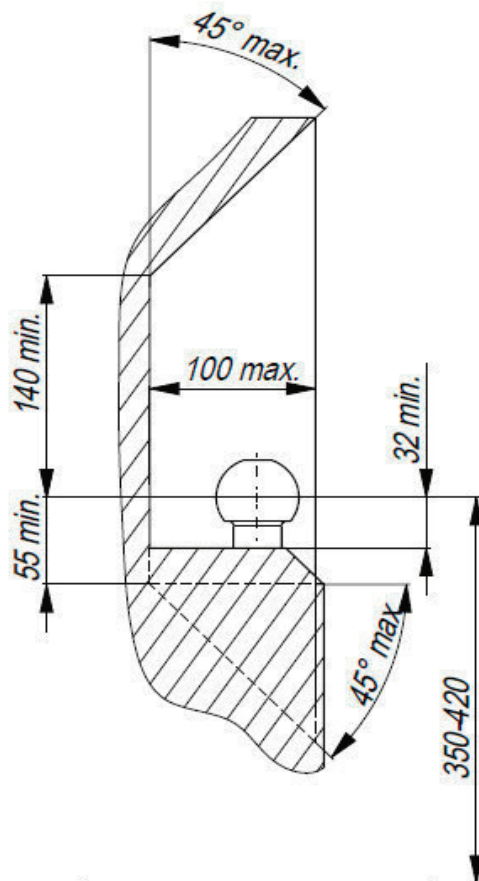

PL Należy zagwarantować przestrzeń swobodną według załącznika VII, rysunek 25a/b Regulaminu EKG ONZ 55.01 przy dopuszczalnym ciężarze całkowitym pojazdu.

F L'espace libre doit être garanti conformément à l'annexe VII, illustration de la réglementation 55.01 CE pour un poids total en charge autorisé du véhicule.







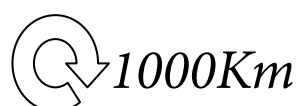

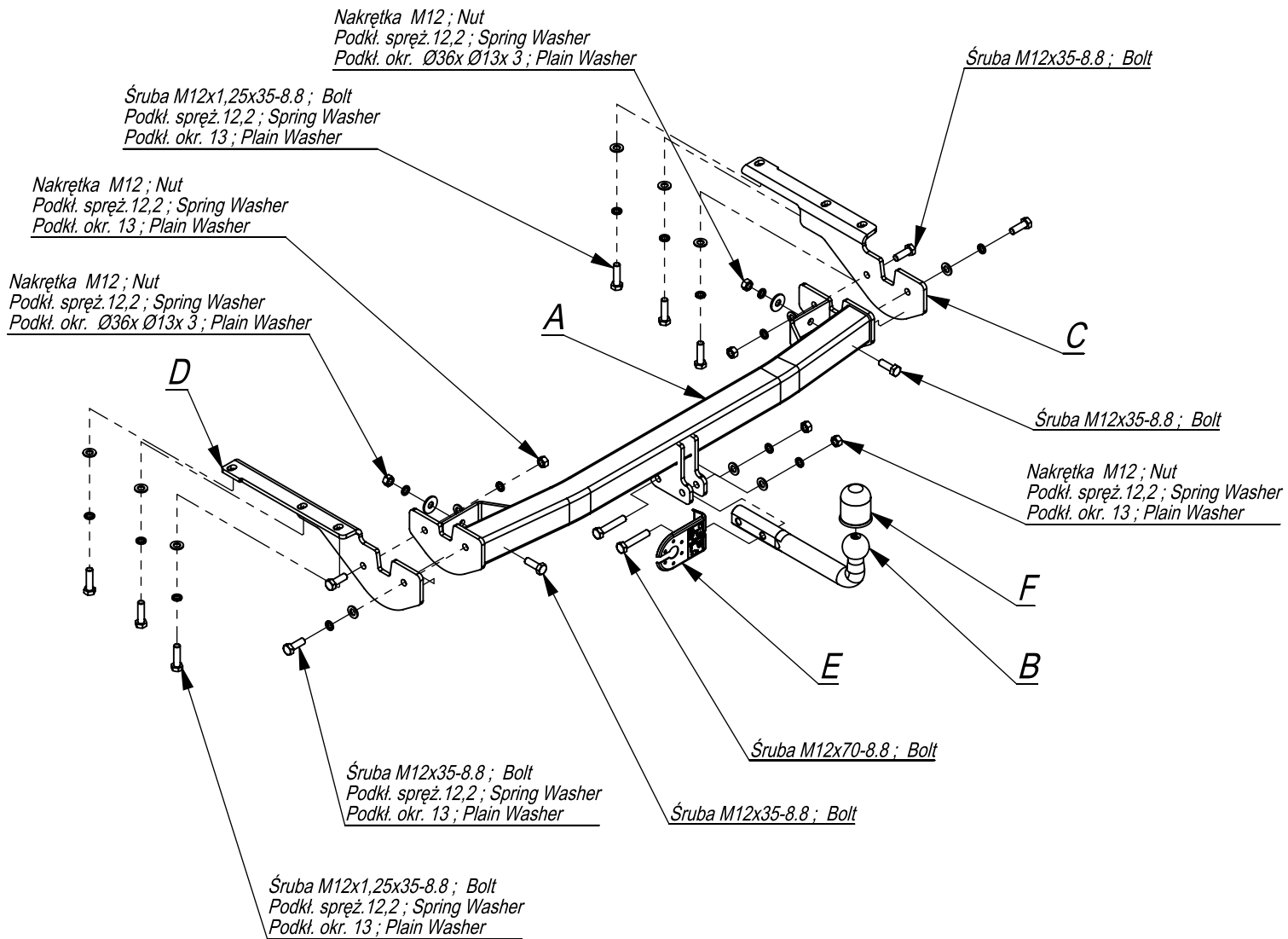
GB The clearance specified in appendix VII, diagram 25a/b of Regulation No. 55.01 UN EU must be guaranteed at laden weight of the vehicle.

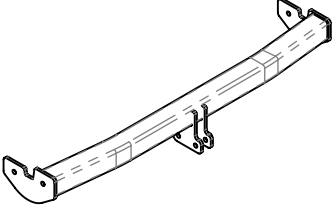
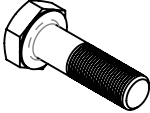
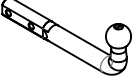
D Der Freiraum nach Anhang VII, Abbildung 25a/b der Vorschriften 55.01 EG ist zu gew 25a/b abzuwehren bei zulässigem Gesamtgewicht des Fahrzeuges

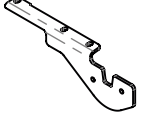
Moment skręcający dla śrub i nakrętek (8.8) Torque settings for nuts and bolts (8.8)	
M8	25Nm
M10	55Nm
M12	85Nm
M14	135Nm
M16	195Nm





	A	x1		M12x70	2
				M12x35	6
				M12x1,25x35	6
	B	x1		M12	6
	C	x1		Ø36xØ13x3	2
	D	x1		13	12
	E	x1		12,2	14
	F	x1			

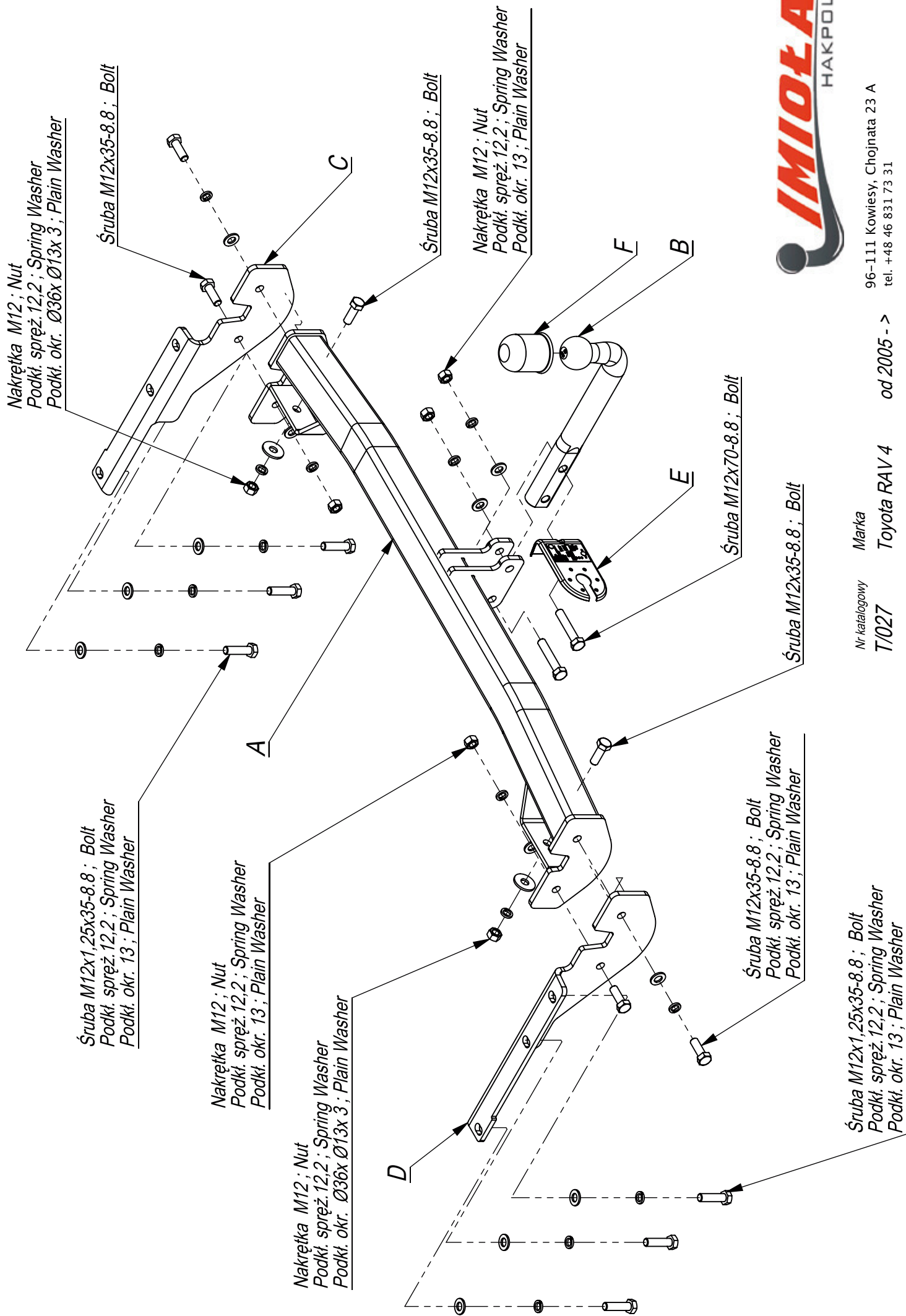

Nr katalogowy
T/027

Marka
Toyota RAV 4

od 2005 ->

96-111 Kowiesy, Chojnata 23 A
 tel. +48 46 831 73 31

- Do spodu podłużnic (w których znajdują się otwory montażowe z gwintami) przykręcić lekko elementy haka C i D śrubami M12x35x1,25 (pkt 1).
- Do elementów haka C i D dokręcić belkę haka A śrubami M12x40 8.8 (pkt 2).
- Przykręcić kulę i blachę gniazda elektrycznego śrubami M12x70 8.8.
- Dokręcić wszystkie śruby z momentem wg tabeli.
- Podłączyć instalację elektryczną.

- Screw slightly the elements C and D to the bottom of the metal clamps (where are located the fitting holes with threads) with bolts M12x35x1,25 (point 1).
- Screw the main bar A to the elements C and D with bolts M12x40 8.8(point 2).
- Fix the ball and electric plate with bolts M12x70 8.8.
- Tighten all the bolts according to the torque setting- see the table.
- Connect the electric wires.
-

- Visser legerement les éléments du crochet C et D aux longerons partie Basse (munis des ouvertures taraudées) par les boulons M12x35x1,25 (point 1),
- Serrer la traverse de crochet A aux éléments C et D avec de boulons M12x35 8.8 (point 2),
- Visser le crochet d'attelage et socle de prise électrique par les boulons M12x70 8.8.,
- Serrer tous les boulons avec un couple de serrage selon tableau,
- Raccorder le circuit électrique.
-

- Von unten der Längsträger, wo sich die Montageöffnungen mit den Gewinden befinden, die Tragteile C und D mit den Schrauben M12x35x1,25 (Punkt 1) locker anschrauben.
- An die Tragteile C und D den Querbalken A mit den Schrauben M12x40 8.8 (Punkt 2) anschrauben.
- Die Kugel und die Steckdosenhalterung mit den Schrauben M12x70 8.8 anschrauben.
- Alle Schrauben mit dem in der Tabelle angegebenen Drehmoment festziehen.
- Die Elektroinstallation anschließen.

- Fijar los elementos C y D del gancho a los largueros con tornillos M12x35x1,25 8.8 (punto 1).
- Fijar el gancho A a los elementos C y D con tornillos M12x35 8.8 (punto 2)..
- Atornille la bola y la placa de toma de corriente eléctrica. con tornillos M12x70 8.8.
- Apretar todos los tornillos al torque de acuerdo con la tabla.
- Conectar la instalación eléctrica.

